

Profile Type B22

Aperture Range from 0.10mm to 14mm

Profile Weight 0.037Kg/m

Product Types

- Ventilation
- Drainage
- Balustrade
- Flooring/Walkway
- Facades.

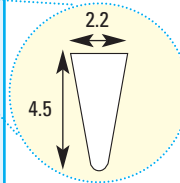
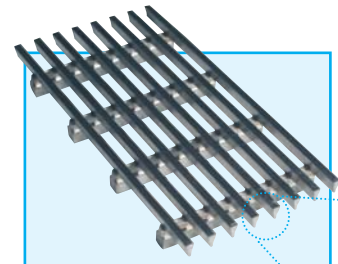

Profile Type B28

Aperture Range from 0.10mm to 14mm

Profile Weight 0.057Kg/m

Product Types

- Ventilation
- Drainage
- Balustrade
- Flooring/Walkway
- Facades.

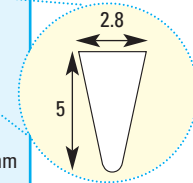
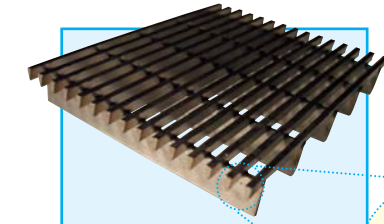

Profile Type B34

Aperture Range from 0.10mm to 14mm

Profile Weight 0.078Kg/m

Product Types

- Ventilation
- Drainage
- Balustrade
- Flooring/Walkway
- Facades.

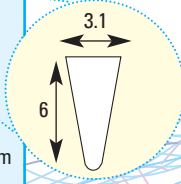
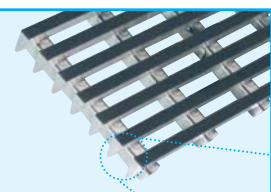

Profile Type B42

Aperture Range from 0.10mm to 14mm

Profile Weight 0.096Kg/m

Product Types

- Ventilation
- Drainage
- Balustrade
- Flooring/Walkway
- Facades.

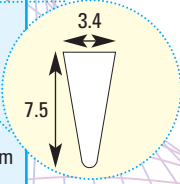
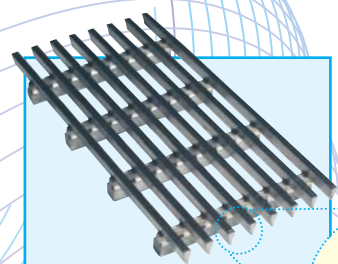

Profile Type B50

Aperture Range from 0.10mm to 14mm

Profile Weight 0.135Kg/m

Product Types

- Ventilation
- Drainage
- Balustrade
- Flooring/Walkway
- Facades.

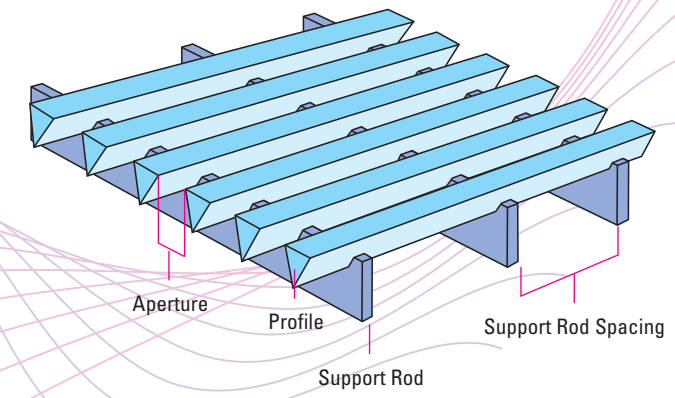

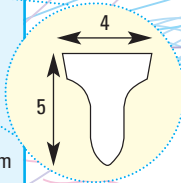
Profile Type	B40
Aperture	Range from 0.10mm to 14mm
Profile Weight	0.099Kg/m
Product Types	Ventilation <input checked="" type="checkbox"/> Drainage <input checked="" type="checkbox"/> Balustrade <input checked="" type="checkbox"/> Flooring/Walkway <input checked="" type="checkbox"/> Facades. <input checked="" type="checkbox"/>

Profile Type	B2.45
Aperture	Range from 0.10mm to 14mm
Profile Weight	0.059Kg/m
Product Types	Ventilation <input checked="" type="checkbox"/> Drainage <input checked="" type="checkbox"/> Balustrade <input checked="" type="checkbox"/> Flooring/Walkway <input checked="" type="checkbox"/> Facades. <input checked="" type="checkbox"/>

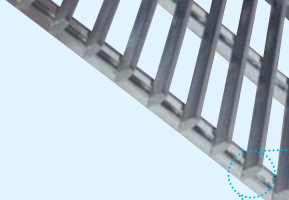
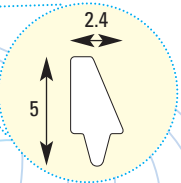
Profile Type	B675
Aperture	Range from 0.10mm to 14mm
Profile Weight	0.164Kg/m
Product Types	Ventilation <input checked="" type="checkbox"/> Drainage <input checked="" type="checkbox"/> Balustrade <input checked="" type="checkbox"/> Flooring/Walkway <input checked="" type="checkbox"/> Facades. <input checked="" type="checkbox"/>

Profile Type	B560
Aperture	Range from 0.10mm to 14mm
Profile Weight	0.144Kg/m
Product Types	Ventilation <input checked="" type="checkbox"/> Drainage <input checked="" type="checkbox"/> Balustrade <input checked="" type="checkbox"/> Flooring/Walkway <input checked="" type="checkbox"/> Facades. <input checked="" type="checkbox"/>

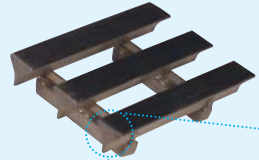
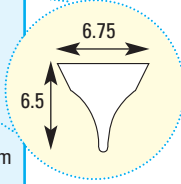
Types of Finish

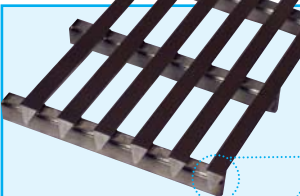
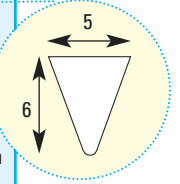
A variety of aesthetically pleasing finishes can be provided as options, to complement our popular Belmont 80 grit satin finish.

- Satin finish
- Electro polished
- Acid cleaned matt
- Bead blasted to satisfy slip resistance criteria
- Powder coated to suit most RAL shades
- Painted
- Mild steel galvanised

This is not an exhaustive list of finishes available but please contact our office for advice on any special requirements.

Fixing Methods

We have a range of fixings that are designed for many differing situations / locations to satisfy architects technical preference and product aesthetic appearance.

- Surface flush mounted fixing blocks
- Hidden spring retention clip system
- Through aperture fixing method
- Drilled frame or attachments for rear fixing
- Interlocking hidden fixing arrangement
- Hidden rear flat keyhole type location
- Surface or hidden hinges for access areas

There are many more alternative fixings available but please contact our office for advice on any specific requirement.

Technical Summary

With regard to product types, which are highlighted in the tick boxes, these denote the most commonly used profiles for these applications. However, alternative profiles can be used in these applications to satisfy the client's technical and aesthetic preference.

Our standard aperture range is shown in these tables but if a larger aperture is required please contact our office to discuss.

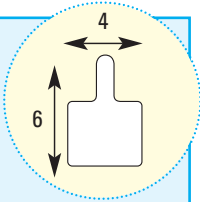

Support Type B50P
Support Pitch Available in 25mm or 50mm

Pedestrian Loading (Spans)
 25mm 0-200mm
 50mm 0-165mm

Support Weight 0.148Kg/m

- Product Types**
- Ventilation
 - Drainage
 - Balustrade
 - Flooring/Walkway
 - Facades.

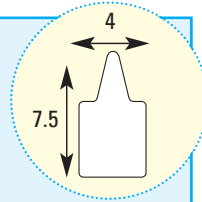

Support Type B55
Support Pitch Available in 25mm or 50mm

Pedestrian Loading (Spans)
 25mm 0-260mm
 50mm 0-210mm

Support Weight 0.19Kg/m

- Product Types**
- Ventilation
 - Drainage
 - Balustrade
 - Flooring/Walkway
 - Facades.

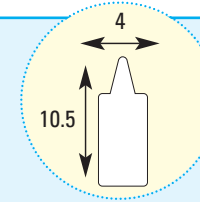

Support Type B750
Support Pitch Available in 25mm or 50mm

Pedestrian Loading (Spans)
 25mm 0-450mm
 50mm 0-350mm

Support Weight 0.298Kg/m

- Product Types**
- Ventilation
 - Drainage
 - Balustrade
 - Flooring/Walkway
 - Facades.

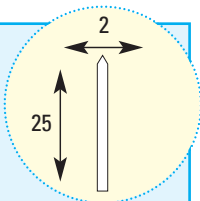

Support Type B25
Support Pitch Available in 25mm

Pedestrian Loading (Spans)
 25mm 0-1000mm
 50mm N/A

Support Weight 0.393Kg/m

- Product Types**
- Ventilation
 - Drainage
 - Balustrade
 - Flooring/Walkway
 - Facades.

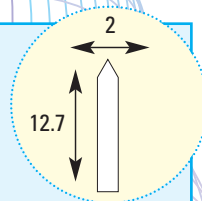

Support Type B12.7
Support Pitch Available in 25mm or 50mm

Pedestrian Loading (Spans)
 25mm 0-600mm
 50mm 0-475mm

Support Weight 0.19Kg/m

- Product Types**
- Ventilation
 - Drainage
 - Balustrade
 - Flooring/Walkway
 - Facades.

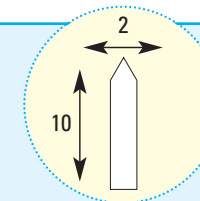

Support Type B10
Support Pitch Available in 25mm or 50mm

Pedestrian Loading (Spans)
 25mm 0-475mm
 50mm 0-375mm

Support Weight 0.157Kg/m

- Product Types**
- Ventilation
 - Drainage
 - Balustrade
 - Flooring/Walkway
 - Facades.